

# Data Sheet



Article number: 12890000030100  
Description: KLEE-coil 890 000 030.100  
M3 Hardened/zinc-pl.

## Measures

---

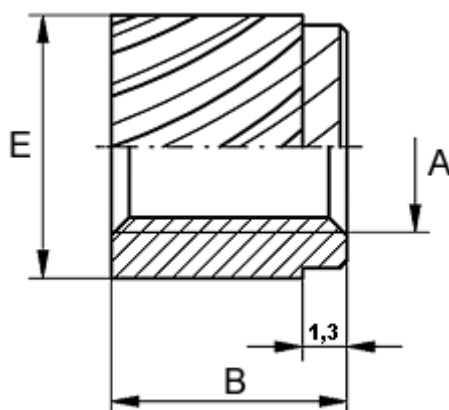

Female thread A	= M3
Length B	= 4.5
Min material thickness	= 2.0
Outer diameter E	= 5.3
Recommended bore diameter	= 4.8
Type	= 890 000 030.100